

Ø16mm XA Series Emergency Stop Switches (Illuminated Type)

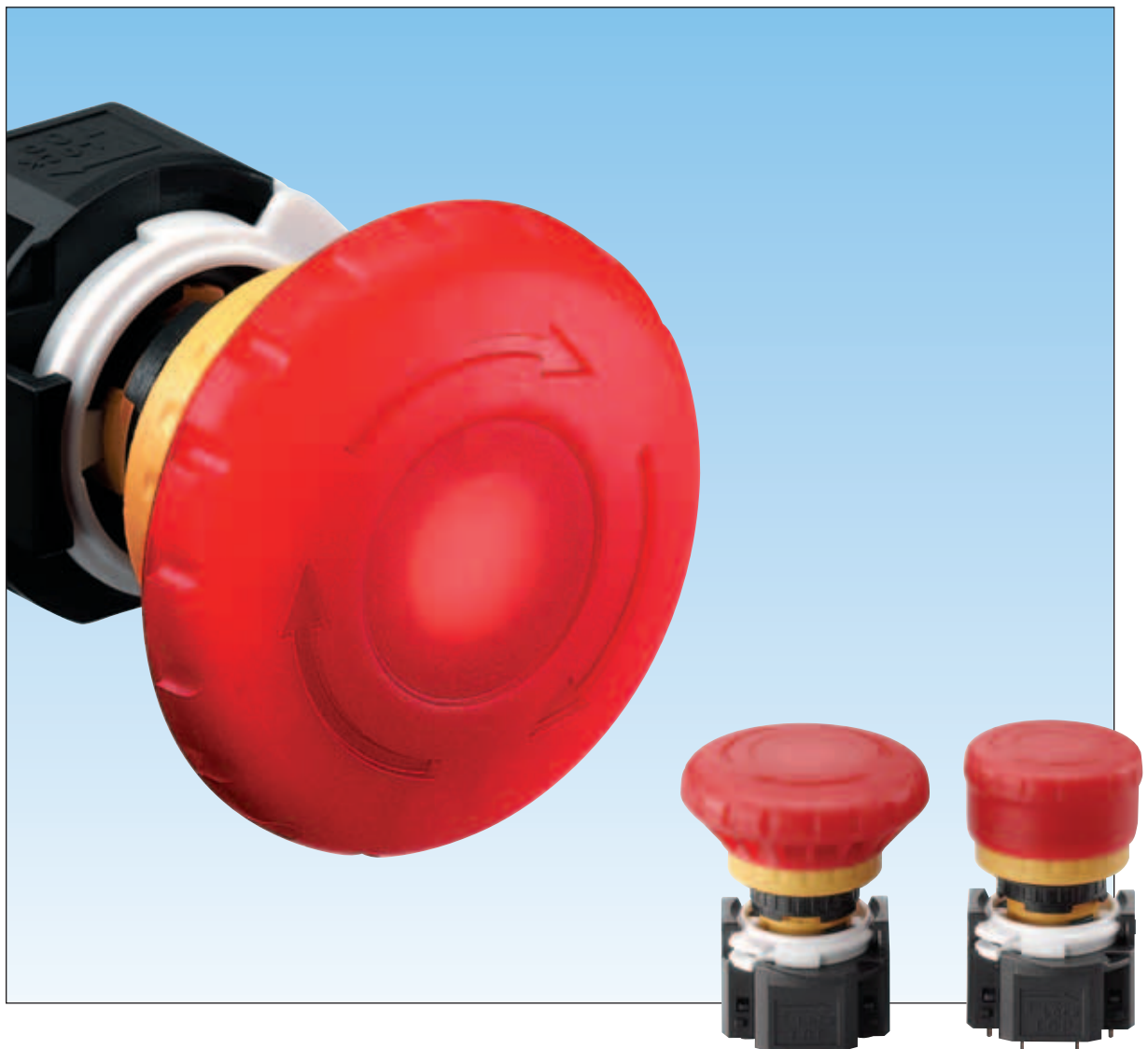

ø16mm XA series Illuminated Emergency Stop Switches

The World's First ø16 mm, 4-contact Emergency Stop Switch.
Compact size - only 27.9 mm deep behind the panel.

- 1 to 4NC main contacts and 1NO monitor contact
- The depth behind the panel is only 27.9 mm for 1 to 4 contacts.
- IDEC's original "Safe break action" ensures that the contacts open when the contact block is detached from the operator.
- Push-to-lock, Pull or Turn-to-reset operator
- Two operator sizes: ø29 and ø40 mm
- Safety lock mechanism (IEC60947-5-5, 6.2)
- Degree of protection IP65 (IEC60529)
- Direct opening action mechanism (IEC60947-5-5, 5.2, IEC60947-5-1, Annex K)
- UL, c-UL recognized. EN compliant
- RoHS compliant (EU directive 2002/95/EC). Contains no lead, cadmium, mercury, hexavalent chromium, PBB, or PBDE.



Illumination Ratings

Rated Voltage	Operating Voltage	Rated Current
24V AC/DC	24V AC/DC ±10%	11 mA

Note: Except for stop switches (operator color: gray).

Contact Ratings (NC main contacts/NO monitor contact)

Rated Insulation Voltage (Ui)		300V (illuminated part: 60V)				
Rated Current (Ith)		5A				
Rated Operating Voltage (Ue)		30V	125V	250V		
Rated Operating Current	Main Contacts	AC 50/60 Hz	Resistive Load (AC-12)	–	3A	3A
			Inductive Load (AC-15)	–	1.5A	1.5A
		DC	Resistive Load (DC-12)	2A	0.4A	0.2A
			Inductive Load (DC-13)	1A	0.22A	0.1A
Monitor Contacts	AC 50/60 Hz	Resistive Load (AC-12)	–	1.2A	0.6A	
		Inductive Load (AC-14)	–	0.6A	0.3A	
	DC	Resistive Load (DC-12)	2A	0.4A	0.2A	
		Inductive Load (DC-13)	1A	0.22A	0.1A	

- Minimum applicable load: 5V AC/DC, 1 mA (reference value) (Operating area may vary according to the operating conditions and load types.)
- The rated operating currents are measured at resistive/inductive load types specified in IEC 60947-5-1.

Standard	Mark	Approval Organization/ File No.
UL508 CSA C22.2 No. 14		UL/c-UL File No. E68961
EN60947-5-1 EN60947-5-5 (Note)		TÜV Product Service
		European Commission's Low Voltage Directive
GB14048.5		CCC No. 2005010305150899

Specifications





Applicable Standards	IEC60947-5-1, EN60947-5-1 IEC60947-5-5 (Note), EN60947-5-5 (Note) JIS C8201-5-1, UL508, CSA C22.2 No. 14
Operating Temperature	–25 to +55°C (no freezing)
Operating Humidity	45 to 85% RH (no condensation)
Storage Temperature	–45 to +80°C
Operating Force	Push to lock: 10.5N Pull to reset: 10N Turn to reset: 0.16 N·m
Minimum Force Required for Direct Opening Action	60N
Minimum Operator Stroke Required for Direct Opening Action	4.0 mm
Maximum Operator Stroke	4.5 mm
Contact Resistance	50 mΩ maximum (initial value)
Insulation Resistance	100 MΩ minimum (500V DC megger)
Overvoltage Category	II
Impulse Withstand Voltage	2.5 kV
Pollution Degree	3 (inside LED unit: 2)
Operation Frequency	900 operations/hour
Shock Resistance	Operating extremes: 150 m/s ² Damage limits: 1000 m/s ²
Vibration Resistance	Operating extremes: 10 to 500 Hz, amplitude 0.35 mm acceleration 50 m/s ² Damage limits: 10 to 500 Hz, amplitude 0.35 mm acceleration 50 m/s ²
Mechanical Life	250,000 operations minimum
Electrical Life	100,000 operations minimum 250,000 operations minimum (24V AC/DC, 100 mA)
Degree of Protection	IP65 (IEC60529)
Short-circuit Protection	250V/10A fuse (Type aM, IEC60269-1/IEC60269-2)
Conditional Short-circuit Current	1000A
Terminal Style	Solder terminal, PC Board terminal
Recommended Tightening Torque for Locking Ring	0.88 N·m
Connectable Wire	1.25 mm ² maximum (AWG16 maximum)
Soldering Conditions	310 to 350°C, 3 seconds maximum
Weight	ø29 mm type: 23g, ø40 mm type: 28g

Note: Except for stop switches (operator color: gray).

ø16mm XA series Illuminated Emergency Stop Switches

Types

Illuminated Solder Terminal / PC Board Terminal Types

Appearance	NC Main Contact	NO Monitor Contact	Type No.		Operator Color
			Terminal Style		
			Solder Terminal	PC Board Terminal	
 	1NC	—	XA1E-LV301Q4R	XA1E-LV301Q4VR	Dark red only
	2NC	—	XA1E-LV302Q4R	XA1E-LV302Q4VR	
	3NC	—	XA1E-LV303Q4R	XA1E-LV303Q4VR	
	4NC	—	XA1E-LV304Q4R	XA1E-LV304Q4VR	
	1NC	1NO	XA1E-LV311Q4R	XA1E-LV311Q4VR	
	2NC	1NO	XA1E-LV312Q4R	XA1E-LV312Q4VR	
 	3NC	1NO	XA1E-LV313Q4R	XA1E-LV313Q4VR	
	1NC	—	XA1E-LV401Q4R	XA1E-LV401Q4VR	
	2NC	—	XA1E-LV402Q4R	XA1E-LV402Q4VR	
	3NC	—	XA1E-LV403Q4R	XA1E-LV403Q4VR	
	4NC	—	XA1E-LV404Q4R	XA1E-LV404Q4VR	
	1NC	1NO	XA1E-LV411Q4R	XA1E-LV411Q4VR	
	2NC	1NO	XA1E-LV412Q4R	XA1E-LV412Q4VR	
	3NC	1NO	XA1E-LV413Q4R	XA1E-LV413Q4VR	

• Terminal cover (XA9Z-VL2) is ordered separately.

Dimensions

• Illuminated Type

Panel Cut-out

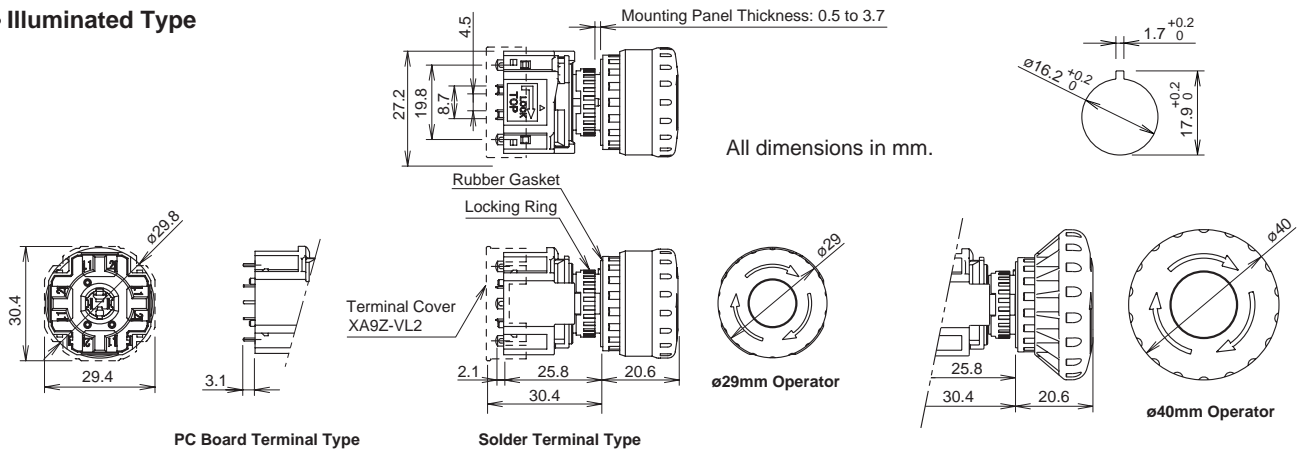

PC Board Layout (Bottom View)

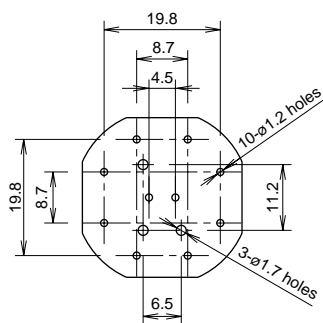

Mounting Hole Layout

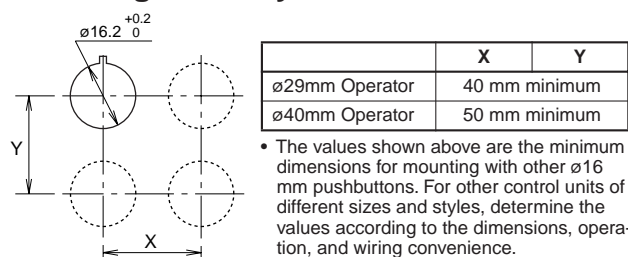

LED Unit Internal Circuit

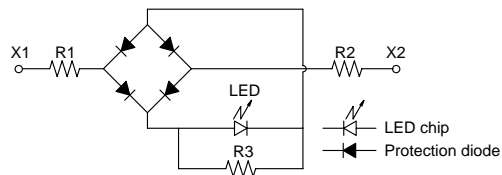

Terminal Arrangement (Bottom View)

Illuminated Type

- **NC main contacts only**
NC main contacts: Terminals 1-2

- **With NO monitor contacts**
NC main contacts: Terminals 1-2
NO monitor contacts: Terminals 3-4

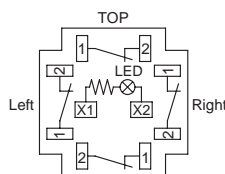

- 1NC: Terminals on right
- 2NC: Terminals on right and left
- 3NC: Terminals on right, left, and top

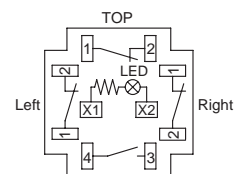



- 1NC: Terminals on top
- 2NC: Terminals on right and left

ø16mm XA series Illuminated Emergency Stop Switches

Nameplates

Description	Legend	Type No.	Material	Plate Color	Legend Color
For ø29mm Operator	(blank)	HAAV-0	Polyamide	Yellow	Black
	EMERGENCY STOP	HAAV-27			
For ø40mm Operator	(blank)	HAAV4-0			
	EMERGENCY STOP	HAAV4-27			

Accessories and Replacement Parts

Description & Appearance	Material	Type No.	Ordering Type No.	Package Quantity	Remarks
Terminal Cover 	PBT	XA9Z-VL2	XA9Z-VL2PN02	2	<ul style="list-style-type: none"> • White • Used for solder terminals.
LED Unit 	For Solder Terminal	XA9Z-LED2R	XA9Z-LED2R	1	• Replacement LED unit/
	For PC Board Terminal	XA9Z-LED2VR	XA9Z-LED2VR		
LED Unit Removal Tool 	Stainless Steel	MT-101	MT-101		• Used for removing the LED unit.

Removing the LED Unit

Pull out the LED unit while squeezing the latches on the LED unit using the LED unit removal tool (MT-101).

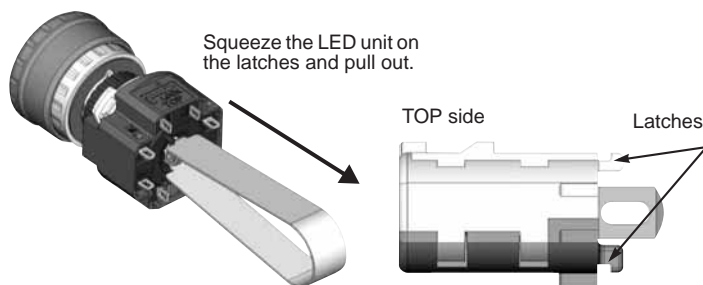

Installing the LED Unit

Align the top of the LED unit with the TOP marking on the contact block. Push the LED unit into the contact block.



Safety Precautions

- Turn off power to the XA series emergency stop switch before starting installation, removal, wiring, maintenance, and inspection of the relays. Failure to turn power off may cause electrical shock or fire hazard.
- Use the LED unit removal tool when replacing the LED unit to avoid burn on your hands.
- Use wires of the proper size to meet the voltage and current requirements, and solder the wires correctly. If soldering is incomplete, the wire may heat during operation, causing fire hazard.
- Read the user's manual to ensure correct operation before starting installation, wiring, operation, maintenance, and inspection of the XA emergency stop switches.

Specifications and other descriptions in this catalog are subject to change without notice.



IDEC CORPORATION

IDEC CORPORATION (USA)
1175 Elko Drive, Sunnyvale, CA 94089-2209, USA
Tel: +1-408-747-0550 / (800) 262-IDEC (4332)
Fax: +1-408-744-9055 / (800) 635-6246
E-mail: opencontact@idec.com

IDEC CANADA LIMITED
Unit 22-151, Brunel Road Mississauga, Ontario,
L4Z 1X3, Canada
Tel: +1-905-890-8561, Toll Free: (888) 317-4332,
Fax: +1-905-890-8562
E-mail: sales@ca.idec.com

IDEC ELECTRONICS LIMITED
Unit 2, Beechwood, Chineham Business Park,
Basingstoke, Hampshire, RG24 8WA, UK
Tel: +44-1256-321000, Fax: +44-1256-327755
E-mail: sales@uk.idec.com

IDEC ELEKTROTECHNIK GmbH
Wendenstrasse 331, D-20537 Hamburg, Germany
Tel: +49-40-25 30 54 10, Fax: +49-40-25 30 54 24
E-mail: service@idec.de

IDEC AUSTRALIA PTY. LTD.
2/3 Macro Court, Rowville, Victoria 3178, Australia
Tel: +61-3-9763-3244, Toll Free: 1800-68-4332,
Fax: +61-3-9763-3255, E-mail: sales@au.idec.com

IDEC IZUMI ASIA PTE. LTD.
No. 31, Tannery Lane #05-01, Dragon Land Building,
Singapore 347788
Tel: +65-6746-1155, Fax: +65-6844-5995
E-mail: info@sg.idec.com

7-31, Nishi-Miyahara 1-Chome, Yodogawa-ku, Osaka 532-8550, Japan
Tel: +81-6-6398-2571, Fax: +81-6-6392-9731
E-mail: products@idec.co.jp

IDEC IZUMI (H.K.) CO., LTD.
Unit 1505-07, DCH Commercial Centre No. 25,
Westlands Road,
Quarry Bay, Hong Kong
Tel: +852-2603-8989, Fax: +852-2565-0171
E-mail: info@hk.idec.com

IDEC (SHANGHAI) CORPORATION
Room 608-609, 6F, Gangtai Plaza, No. 700,
Yan'an East Road, Shanghai 200030, China
Tel: +86-21-5353-1000, Fax: +86-21-5353-1263
E-mail: idec@cn.idec.com

IDEC TAIWAN CORPORATION
8F, No. 79, Hsin Tai Wu Road, Sec. 1, Hsi-Chih,
Taipei County, Taiwan
Tel: +886-2-2698-3929, Fax: +886-2-2698-3931
E-mail: service@idecwn.com.tw

www.idec.com