

Spezifikation für Freigabe / specification for release

Kunde / customer :

Artikelnummer / part number :

744312025

LF



Bezeichnung : **SMD HOCHSTROMINDUKTIVITÄT WE-HC**
 description : **SMD POWER CHOKE WE-HC**

DATUM / DATE : 2005-04-18

A Mechanische Abmessungen / dimensions :

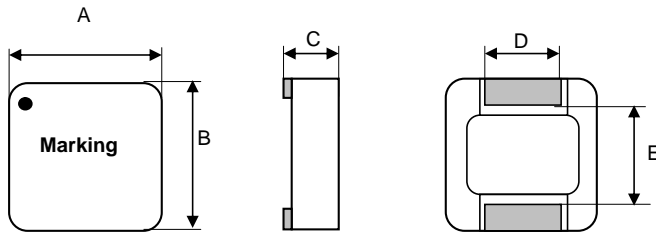

● = Indication start of winding

A	6,6 ± 0,4	mm
B	7,3 ± 0,4	mm
C	3,4 ± 0,4	mm
D	2,5 ± 0,4	mm
E	4,3 ± 0,4	mm
F		mm
G		mm
H		mm

B Elektrische Eigenschaften / electrical properties :

Eigenschaften / properties	Testbedingungen / test conditions		Wert / value	Einheit / unit	tol.
Lerrlaufinduktivität / initial inductance	100 kHz / 0,1V	L_o	0,25	μ H	$\pm 20\%$
Nenn-Induktivität / rated inductance	100 kHz / 0,1V / 18A	L_N	0,210	μ H	typ.
DC-Widerstand / DC-resistance	@ 20° C	$R_{DC \text{ typ}}$	1,86	m Ω	typ.
DC-Widerstand / DC-resistance	@ 20° C	$R_{DC \text{ max}}$	2,50	m Ω	max.
Nennstrom / rated current	$\Delta T = 50 \text{ K}$	I_{DC}	18,0	A	typ.
Sättigungsstrom / saturation current	$\Delta L/L_o = -30\%$	I_{sat}	36,0	A	typ.
Eigenres.-Frequenz / self.res.-frequency		SRF	275,0	MHz	ref.

C Lötpad / soldering spec. :

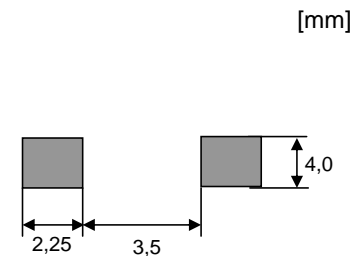

D Prüfgeräte / test equipment :

HP 4274 A für/for L und/and Q
HP 34401 A für/for I_{DC} und/and R_{DC}

E Testbedingungen / test conditions :

Luftfeuchtigkeit / humidity: 33%
 Umgebungstemperatur / temperature: + 25°C

F Werkstoffe & Zulassungen / material & approvals :

Kernmaterial / core material: WE-Superflux 200
 Draht / wire: Flatwire/ Flachdraht UL94-V0; 2UEWF 155°C

G Eigenschaften / granted properties :

Arbeitstemperatur / operating temperature: -40°C - +150°C
 Umgebungstemp. / ambient temperature: -40°C - +100°C
 It is recommended that the temperature of the part does not exceed 150°C under worst case operating conditions.

Freigabe erteilt / general release:	Kunde / customer		
	Unterschrift / signature		
Datum / date	Würth Elektronik		
Geprüft / checked	Kontrolliert / approved		
	Name	Änderung / modification	Datum / date
	ME	Version 6	2005-04-18
	MST	Version 5	2004-11-09
	MST	Version 4	2004-10-11
	AG	Version 3	2003-06-11
	AG	Version 2	2003-03-12
	JH	Neugestaltung	2000-12-06

Würth Elektronik eiSos GmbH & Co. KG

D-74638 Waldenburg · Max-Eyth-Strasse 1 - 3 · Germany · Telefon (+49) (0) 7942 - 945 - 0 · Telefax (+49) (0) 7942 - 945 - 400
<http://www.we-online.com>

Spezifikation für Freigabe / specification for release

Kunde / customer :

Artikelnummer / part number :

744312025

LF



Bezeichnung : **SMD HOCHSTROMINDUKTIVITÄT WE-HC**

description : **SMD POWER CHOKE WE-HC**

DATUM / DATE : 2005-04-18

H Induktivitätskurve / Inductance curve :

**Induktivität vs Strom (typ.)
Inductance vs Current (typ.)**

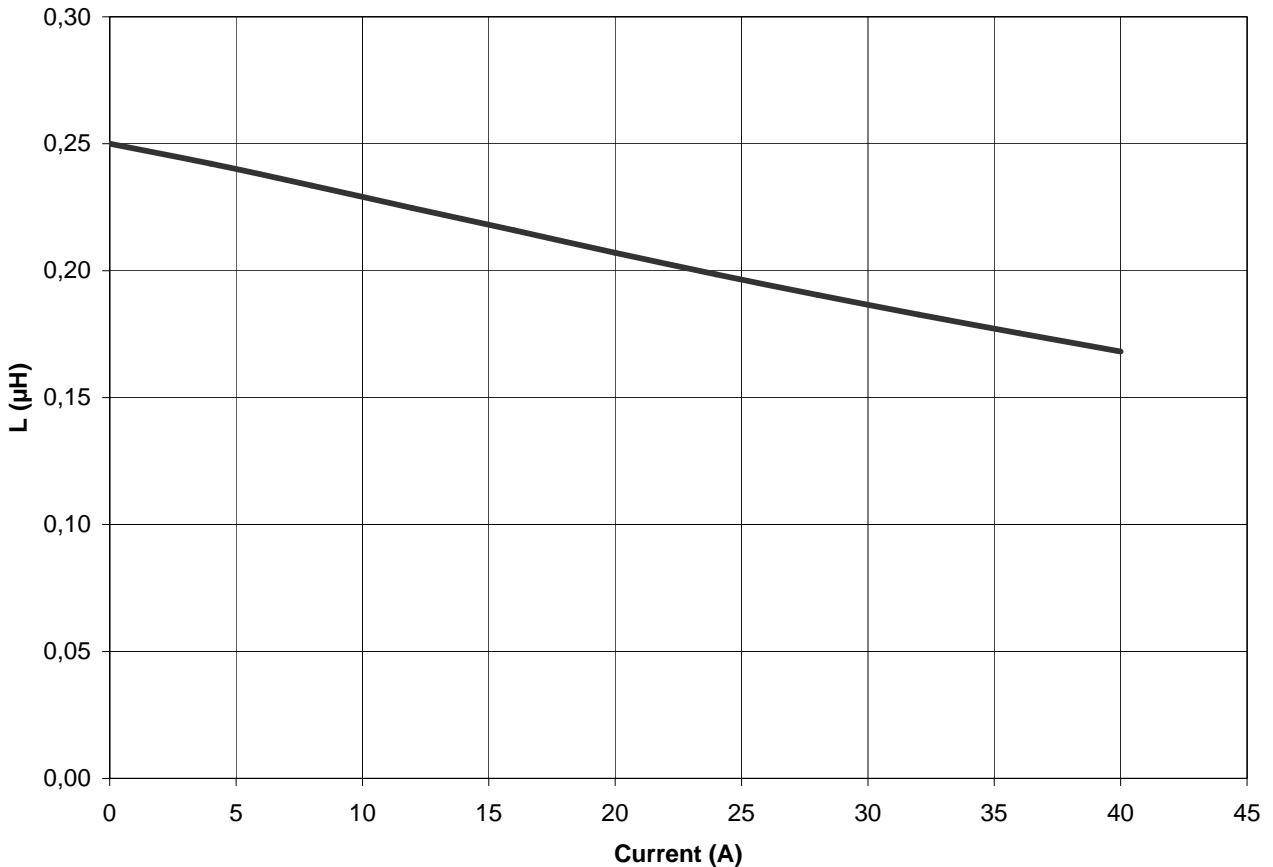

Freigabe erteilt / general release:	Kunde / customer			
Datum / date	Unterschrift / signature			
Geprüft / checked	Kontrolliert / approved			
	Würth Elektronik			
		ME	Version 6	2005-04-18
		MST	Version 5	2004-11-09
		MST	Version 4	2004-10-11
		AG	Version 3	2003-06-11
		AG	Version 2	2003-03-12
		JH	Neugestaltung	2000-12-06
		Name	Änderung / modification	Datum / date

Würth Elektronik eiSos GmbH & Co. KG

D-74638 Waldenburg · Max-Eyth-Strasse 1 - 3 · Germany · Telefon (+49) (0) 7942 - 945 - 0 · Telefax (+49) (0) 7942 - 945 - 400
http://www.we-online.com

Spezifikation für Freigabe / specification for release

Kunde / customer :
 Artikelnummer / part number :
 Bezeichnung :
 description :

744312025

LF



I Temperaturanstieg / Temperature rise curve :

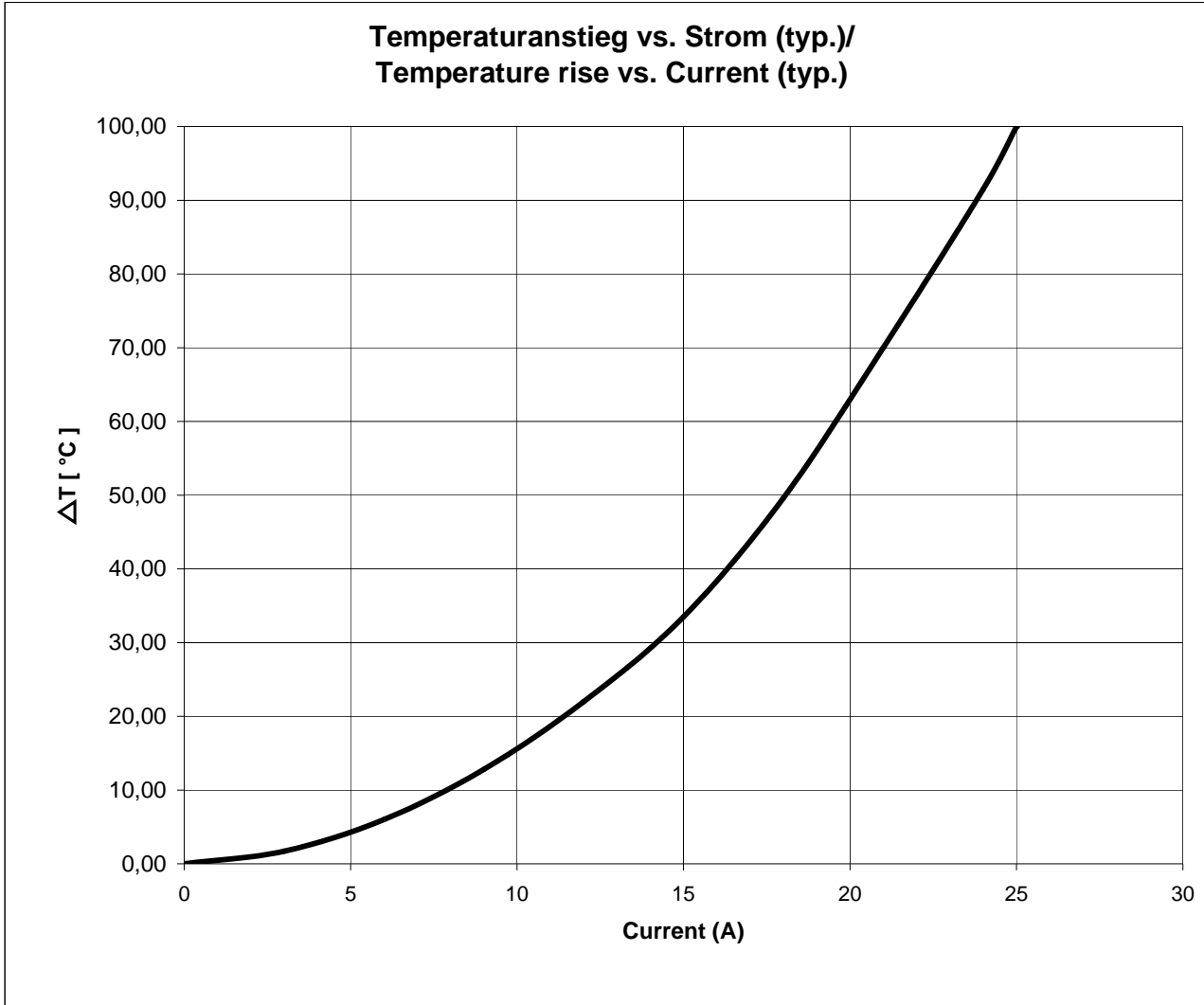

Freigabe erteilt / general release:	Kunde / customer		
		ME	Version 6 2005-04-18
Datum / date	Unterschrift / signature	MST	Version 5 2004-11-09
		MST	Version 4 2004-10-11
		Würth Elektronik	AG
			Version 3 2003-06-11
			AG
			Version 2 2003-03-12
Geprüft / checked	Kontrolliert / approved	JH	Neugestaltung 2000-12-06
		Name	Änderung / modification
			Datum / date

Würth Elektronik eiSos GmbH & Co. KG

D-74638 Waldenburg · Max-Eyth-Strasse 1 - 3 · Germany · Telefon (+49) (0) 7942 - 945 - 0 · Telefax (+49) (0) 7942 - 945 - 400
<http://www.we-online.com>

Spezifikation für Freigabe / specification for release

Kunde / customer :

Artikelnummer / part number :

744312025



Bezeichnung : **SMD HOCHSTROMINDUKTIVITÄT WE-HC**
 description : **SMD POWER CHOKE WE-HC**

DATUM / DATE : 2005-04-18

J Rollenspezifikation / tape and reel specification :

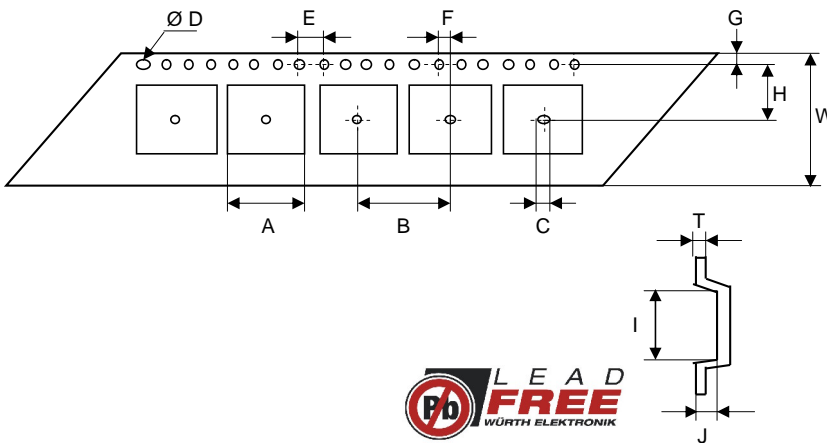

Gurtspezifikation / Tape specification:		
A	7,20 ± 0,1	mm
B	12,0 ± 0,1	mm
C	1,50^{+0,1}_{-0,0}	mm
D	1,50^{+0,1}_{-0,0}	mm
E	4,00 ± 0,1	mm
F	2,00 ± 0,1	mm
G	1,75 ± 0,1	mm
H	7,50 ± 0,1	mm
I	7,80 ± 0,1	mm
J	3,70 ± 0,1	mm
T	0,30 ± 0,1	mm
W	16,0 ± 0,3	mm

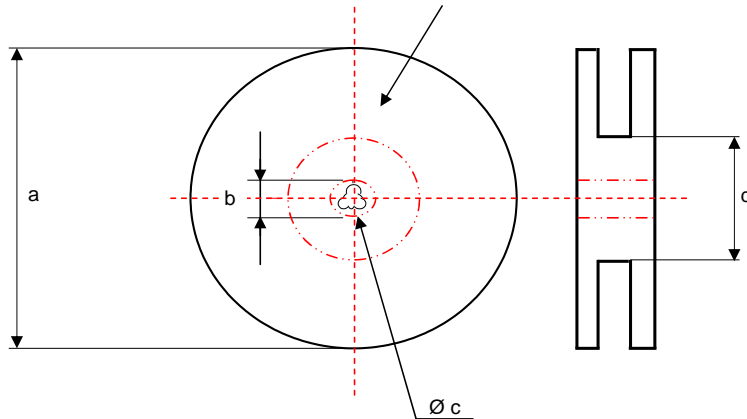

Rollenspezifikation / Reel specification:		
a	330,0 ± 0,5	mm
b	20,20 ± 0,1	mm
c	13,00^{+0,5}_{-1,0}	mm
d	100,0 ± 1,0	mm

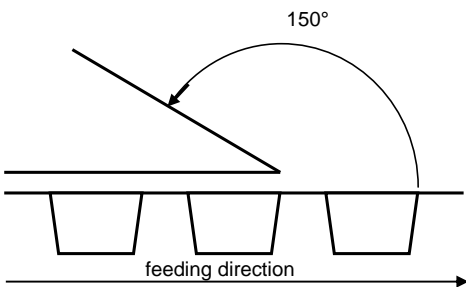

The Force for tearing off cover tape is 20 to 70 grams in arrow direction

Freigabe erteilt / general release:	Kunde / customer		
		
Datum / date	Unterschrift / signature		
		
Geprüft / checked	Würth Elektronik		
		
Kontrolliert / approved	Name		
		

ME	Version 6	05-04-18
MST	Version 5	04-11-09
MST	Version 4	04-10-11
AG	Version 3	03-06-11
AG	Version 2	03-03-12
JH	Neugestaltung	00-12-06
Name	Änderung / modification	Datum / date

This electronic component is designed and developed with the intention for use in general electronics equipments. Before incorporating the components into any equipments in the field such as aerospace, aviation, nuclear control, submarine, transportation, (automotive control, train control, ship control), transportation signal, disaster prevention, medical, public information network etc. where higher safety and reliability are especially required or if there is possibility of direct damage or injury to human body. In addition, even electronic component in general electronic equipments, when used in electrical circuits that require high safety, reliability functions or performance, the sufficient reliability evaluation-check for the safety must be performed before use. It is essential to give consideration when to install a protective circuit at the design stage.

Würth Elektronik eiSos GmbH & Co. KG

D-74638 Waldenburg · Max-Eyth-Strasse 1 - 3 · Germany · Telefon (+49) (0) 7942 - 945 - 0 · Telefax (+49) (0) 7942 - 945 - 400
<http://www.we-online.com>