

13 12 11 10 9 8 7 6 5 4 3 2 1

J I H G F E D C B A

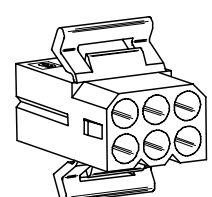

RECEPTACLE

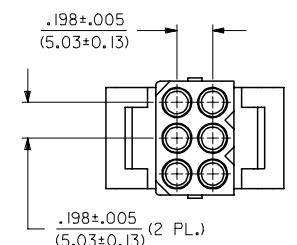
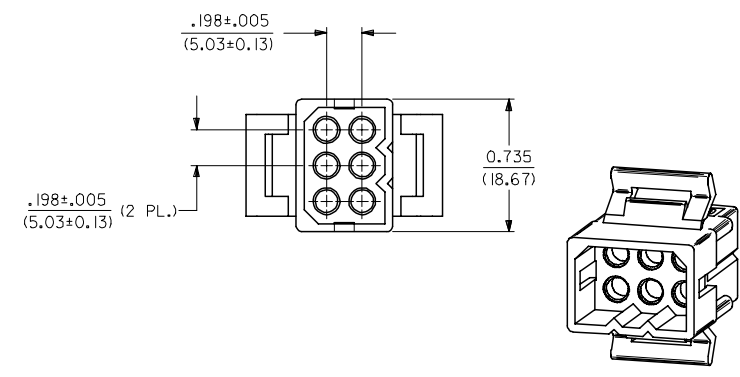
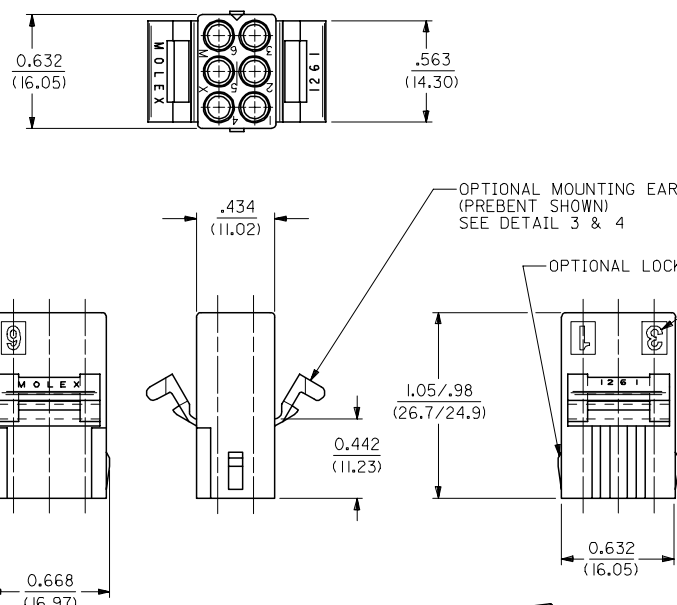
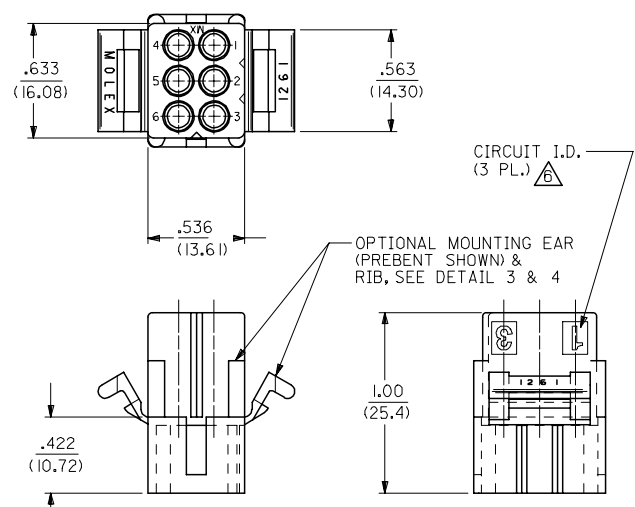
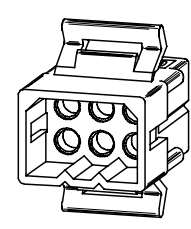

PLUG

REVISED NOTES EC NO: UCP2006-2424 DRAWN: P. DDER 2006/06/08 CHKD: AELHAG 2006/06/08 APPR: FSM TH 2006/06/09	QUALITY SYMBOLS 	GENERAL TOLERANCES (UNLESS SPECIFIED)		DIMENSION STYLE IN/MM		SCALE 2:1	DESIGN UNITS INCH	THIRD ANGLE PROJECTION	
		mm	INCH	DRAWN BY	DATE	TITLE			
		4 PLACES ± .005	± .005	GWC	11/6/89	.093/(2.36) HOUSING, PLUG AND RECEPTACLE, 6 CKT., .198/(5.03)CTRS.			
		3 PLACES ± .007	± .007	CHECKED BY	DATE	MOLEX INCORPORATED			
2 PLACES ± 0.18	± 0.10	RW	11/6/89	MATERIAL NO. DOCUMENT NO. SHEET NO.					
1 PLACE ± 0.25	± .005	APPROVED BY	DATE	SEE CHART		SD-1261-*		1 OF 2	
ANGULAR ± 2 °		GWF	11/6/89	THIS DRAWING CONTAINS INFORMATION THAT IS PROPRIETARY TO MOLEX INCORPORATED AND SHOULD NOT BE USED WITHOUT WRITTEN PERMISSION					
DRAFT WHERE APPLICABLE MUST REMAIN WITHIN DIMENSIONS		SIZE C							

12 11 10 9 8 7 6 5 4 3 2 1

13 12 11 10 9 8 7 6 5 4 3 2 1

PLUG

PART NO.	ENG. NO.
03-09-2061	I261-P
23-09-2061	I261-P-100
03-09-2062	I261-P1
23-09-2062	I261-P1-100
03-09-7061	I261-PBK
03-09-7062	I261-P1BK
27-09-2093	I261-P1-200
50-29-0099	I261-P1-300

RECEPTACLE

PART NO.	ENG. NO.
03-09-1061	I261-R
23-09-1061	I261-R-100
03-09-1062	I261-R1
23-09-1062	I261-R1-100
03-09-1063	I261-R2
23-09-1063	I261-R2-100
03-09-1064	I261-R3
27-09-1063	I261-R2-200
03-09-6064	I261-R3BK
03-09-6063	I261-R2BK
03-09-6062	I261-R1BK
03-09-6061	I261-RBK
50-29-1500	I261-R3-300

LEGEND: PLUG

I261-P***-***
 P = PLUG
 BLANK = PLUG WITH PREBENT MOUNTING EARS
 I = PLUG WITHOUT MOUNTING EARS
 COLOR: BLANK=NATURAL COLOR
 AM=AMBER BK=BLACK BU=BLUE
 BN=BROWN GY=GRAY GN=GREEN
 OR=ORANGE RD=RED YW=YELLOW
 MATERIAL: BLANK = NYLON 6/6, U.L. 94V-2
 100 = POLYPROPYLENE, U.L. 94V-0
 200 = NYLON 6/6, U.L. 94V-0, RED
 300 = NYLON 6/6, U.L. 94V-2, BLACK
 UV RESISTANT

LEGEND: RECEPTACLE

I261-R***-***
 R = RECEPTACLE
 BLANK = WITH STD. MOUNTING EARS, WITH LOCK RAMPS
 1 = WITH STD. MOUNTING EARS, WITHOUT LOCK RAMPS
 2 = WITHOUT MOUNTING EARS, WITHOUT LOCK RAMPS
 3 = WITHOUT MOUNTING EARS, WITH LOCK RAMPS
 4 = WITH PREBENT MOUNTING EARS, WITH LOCK RAMPS
 5 = WITH PREBENT MOUNTING EARS, WITHOUT LOCK RAMPS
 COLOR: BLANK=NATURAL COLOR
 AM=AMBER BK=BLACK BU=BLUE
 BN=BROWN GY=GRAY GN=GREEN
 OR=ORANGE RD=RED YW=YELLOW
 MATERIAL: BLANK = NYLON 6/6, U.L. 94V-2
 100 = POLYPROPYLENE, U.L. 94V-0
 200 = NYLON 6/6, U.L. 94V-0, RED
 300 = NYLON 6/6, U.L. 94V-2, BLACK
 UV RESISTANT

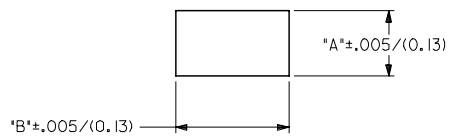
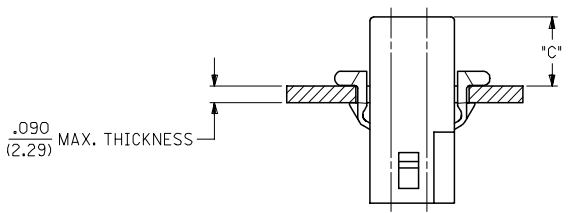

MOUNTING HOLE CUTOUT

HOUSING	DIM. 'A'	DIM. 'B'	DIM. 'C' (STD. EAR)	DIM. 'C' (PREBENT)
PLUG	.750/(19.05)	.695/(17.65)	.39/(9.9)	.40/(10.1)
RECEPTACLE	.718/(18.24)	.600/(15.24)	.40/(10.1)	.41/(10.3)

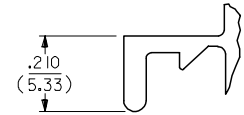

DETAIL 3

.093/(2.36) STANDARD MOUNTING EAR
 (SCALE 4:1)

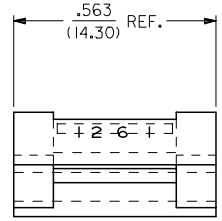

DETAIL 4

.093/(2.36) PREBENT MOUNTING EAR
 (SCALE 4:1)

NOTES:

- MATERIAL: SEE LEGEND
- FINISH: NONE.
- PRODUCT SPECIFICATION: PS-43660-9999
- PACKAGING INFORMATION: PK-1261-001
- HOUSINGS FOR USE WITH MOLEX .093/(2.36) PIN AND SOCKET TERMINALS.
- CIRCUIT I.D. NUMBERS ON SIDE OF HOUSING APPEAR ON PARTS FROM TOOLS BUILT AFTER 9/3/91.
- WHERE DENOTED IN CHART, TOOLS ARE BUILT WITH PREBENT MOUNTING EARS PER DETAIL 4 AND SUPERSEDE ALL TOOLS PREVIOUSLY BUILT WITH THE STANDARD MOUNTING EAR.
- TEXT AND CIRCUIT IDENTIFIERS ARE SHOWN IN APPROXIMATE LOCATION BUT MAY VARY TO ACCOMMODATE TOOLING.

UPDATED NOTES EC NO: UCP2006-2424 DRAWN: P1 DDER 2006/06/08 CHKD: AELHAG 2006/06/08 APPR: FSM TH 2006/06/09	QUALITY SYMBOLS ▽=0 ▽=0	GENERAL TOLERANCES (UNLESS SPECIFIED) mm INCH 4 PLACES ± .18 ± .007 3 PLACES ± .18 ± .010 2 PLACES ± 0.25 ± .010 1 PLACE ± 0.25 ± .010 ANGULAR ± 2 °	DIMENSION STYLE IN/MM DRAWN BY DATE GJC 11/10/89 CHECKED BY DATE RW 11/10/89 APPROVED BY DATE GWF 11/10/89	SCALE 4:1 DESIGN UNITS INCH THIRD ANGLE PROJECTION
		DRAFT WHERE APPLICABLE MUST REMAIN WITHIN DIMENSIONS	MATERIAL NO. SEE CHART SIZE C	SHEET NO. 2 OF 2 MOLEX INCORPORATED SD-1261-*

12 11 10 9 8 7 6 5 4 3 2 1