

FEATURES/BENEFITS

- Short-circuit protected
- Overload trip
- Low off-state leakage current
- Optical isolation
- Compact package

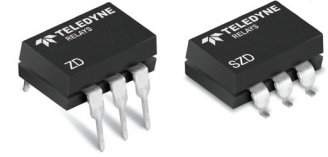

Part Number	Description
ZD20CD*	1A, 80 Vdc, short-circuit protected up to 60 Vdc, solid-state relay for through-hole mounting
SZD20CD*	1A, 80 Vdc, short-circuit protected up to 60 Vdc, solid-state relay for surface mount

*T, W level screening available

ELECTRICAL SPECIFICATIONS
(-55°C to +105°C ambient temperature unless otherwise specified)

INPUT (CONTROL) SPECIFICATIONS

	Min	Max	Units
Input Current	8	20	mA
Input Voltage @ 10mA	2	3	Vdc
Must Turn-On	8		mA
Must Turn-Off Current		100	µA
Must Turn-Off Voltage		0.8	Vdc
Reverse Polarity	-6		Vdc

OUTPUT (LOAD) SPECIFICATIONS

	Min	Max	Units
Load Voltage Range	0	80	Vdc
Output Current Rating (See Figure 6)		1.0	A
Leakage Current at Rated Voltage		20	µA
Transient Blocking Voltage @25°C		100	Vdc
Output Capacitance @25Vdc (25°C)		600	pF
Output Voltage Drop @ 1A		0.55	Vdc
On Resistance		0.55	Ohm
Turn-On Time		2.0	ms
Turn-Off Time		1.0	ms
Trip Overload	(See Figure 7)		A
Short Circuit Protection		60	Vdc

MECHANICAL SPECIFICATIONS

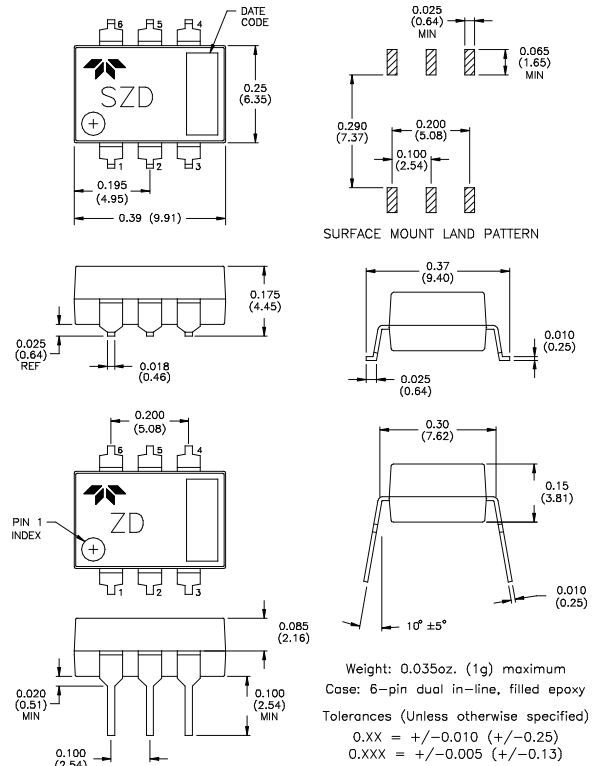
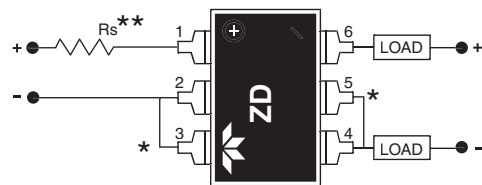

Figure 1

TYPICAL WIRING DIAGRAM



*Shorted internally
**Series resistor required to limit input current to 20mA maximum

Figure 2

FUNCTIONAL BLOCK DIAGRAM

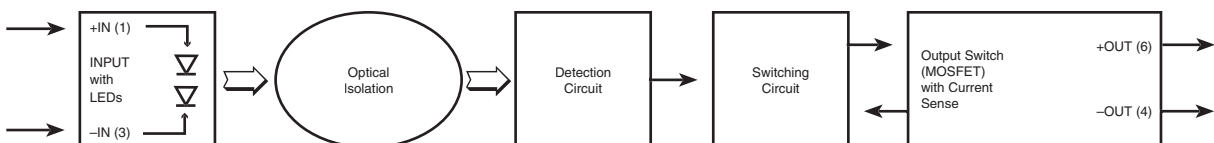

Figure 3

GENERAL SPECIFICATIONS

(+25°C ambient temperature unless otherwise specified)

ENVIRONMENTAL SPECIFICATIONS

	Min	Max	Units
Operating Temperature	-55	+105	°C
Storage Temperature	-55	+125	°C
Junction Temperature @ 1A		+125	°C
Thermal Resistance θ_{JA}		+125	°C/W
Shock	1500		g
Vibration	100		g
Dielectric Strength	1500		Vac
Insulation Resistance (@ 500 Vdc)	10 ⁹		Ohm
Input to Output Capacitance		5	pF
Resistance to Soldering Heat	MIL STD 202, method 210		
Solderability	MIL STD 202, method 208		
Thermal Shock	MIL STD 202, method 107		

CONTROL CURRENT VS. INPUT VOLTAGE



Figure 4

TYPICAL TURN-ON TIME VS. INPUT CURRENT

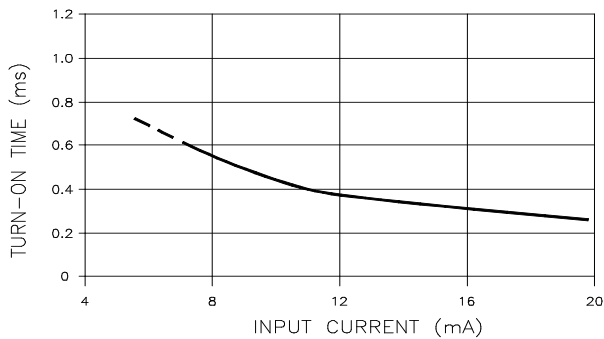

Figure 5

LOAD CURRENT VS. AMBIENT TEMPERATURE

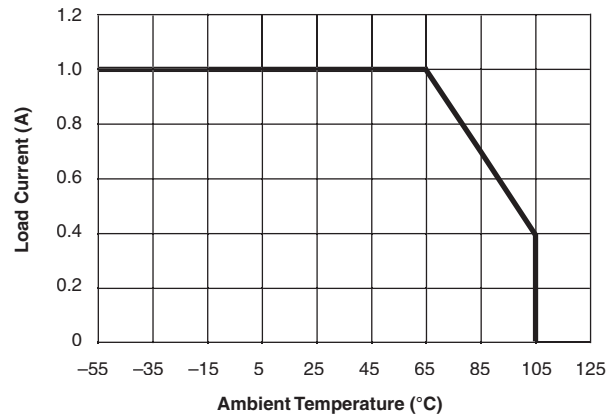

Figure 6

TYPICAL OVERLOAD TRIP CURRENT VS. TIME

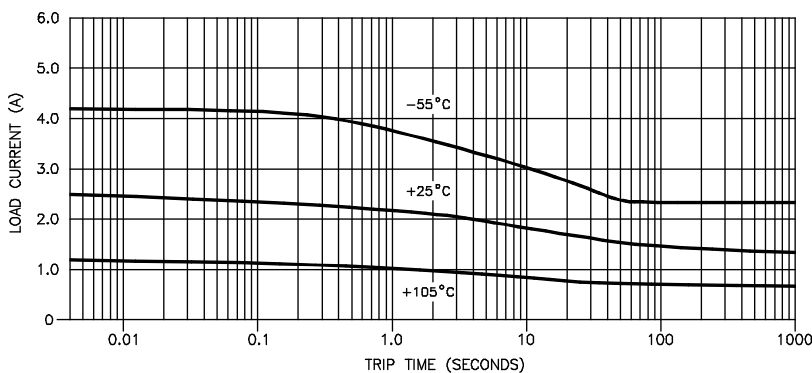

Figure 7

NOTES:

1. The ZD20CD relay's input current should be limited to between 8 and 20mA. An external resistor whose value = $(V_{in} - 2.5 \text{ volts}) \div 0.012$ Amps is a good choice for limiting input current.
2. Relay input transitions should be less than 1.0 millisecond.
3. Loads may be attached to either the positive or negative output terminal.
4. Maximum load current ratings are with the relay in free air and soldered to a printed circuit board.
5. Timing is measured from the input current transition to the 10% or 90% points on the output voltage transition.
6. Overload conditions (including shorted loads) are specified for load supply voltages to 60 Vdc maximum.
7. For through-hole-PCB-solder-attaching ZD20CD series relays, the wave-solder or solder pot operations are limited to +260°C maximum for 10 seconds, maximum.
8. For surface-mount-solder-attaching SZD20CD series relays, in IR heating or convection heating systems, the component temperature is limited to +235°C maximum for 10 seconds maximum.