

Pushbutton Switches

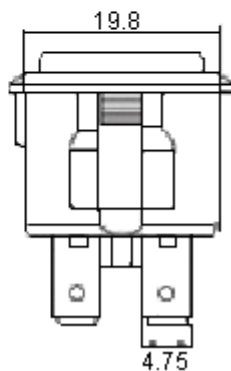

Features:

- Material : frames are nylon. Terminals are silver plated brass.
- Illuminated actuators are moulded in PC, available with red, amber and green colours.
- Water proof and dust proof to fit IP-66.

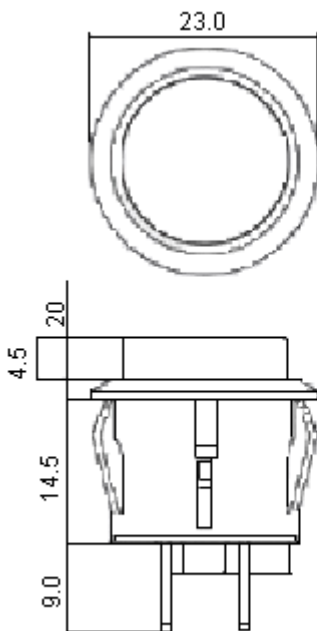

Cut-out

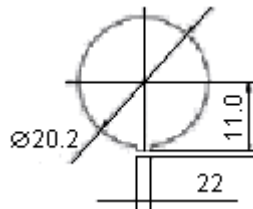

Button

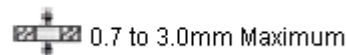

Cut-out for X2 Button

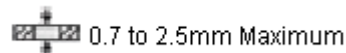
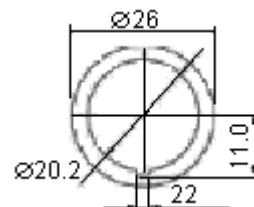

Dimensions : Millimetres

Specifications:

Rating	: 10A, 125V ac 1/2HP 6A, 250V ac 1/2HP.
Maximum contact resistance	: 50mΩ.
Minimum insulation resistance	: 500V dc, 100MΩ.
Dielectric strength	: 1000V ac for 1 minute.



Pushbutton Switches



Scope

These requirements cover manually and mechanically operable special-use switches:

That is for use on direct current as well as on alternating current only.

For which the load ratings do not exceed 60 amperes at 250 volts or a lower potential and 30 amperes or 2 horsepower at 600 volts or a lower potential.

Electrical Ratings

Item	Requirements
Rated voltage and current	(base on switch type)
Contact resistance (new state)	<100mΩ (5V, 1A dc)
Dielectric strength (new state)	>1000V >2500V (10mA between the contacts)
Insulation resistance (new state)	>100MΩ (500V dc between the open contacts)
Inrush current	50A/3msec (capacitive load)
Electrical life endurance	>6000 operations Volt drop : <100mV >10,000 operations
Temperature rise at the terminals (according to electrical life endurance)	<30°C - 6000 operations <45°C - 10,000 operations (ambient conditions : 25 ±2°C and 65 ±5%R.H)

Mechanical Characteristics

Item	Requirements
Actuating force	(base on switch type)
Operating life endurance	>100,000 operations
Terminal strength	>2.5kg - solder terminal >6.8kg - plug-in/screw terminal
Solderability of terminals	Maximum 350°C/3sec (no pressure may be exerted on the terminals when soldering by hand)

Environmental

Item	Requirements
Ambient temperature	-20°C to +65°C
Humidity	Maximum 85%
Salt spray test	No remarkable rust in metal parts (5% salt/35°C 24hrs)
Shock test	No mechanical defect or damage (100g/10msec X, Y, Z 3 times)
Vibration test	No mechanical defect damage (10-55Hz/1.5mm/X, Y, Z 2hrs)

Pushbutton Switches



Part Number Table

Description	Part Number
Switches	R13-527D-02-BB
	R13-527C-02-BB
	R13-527B-02-BB
	R13-527A-02-BB
	R13-527D2-02-BB
	R13-527C2-02-BB
	R13-527B2-02-BB
	R13-527A2-02-BB

Part Number Explanation:

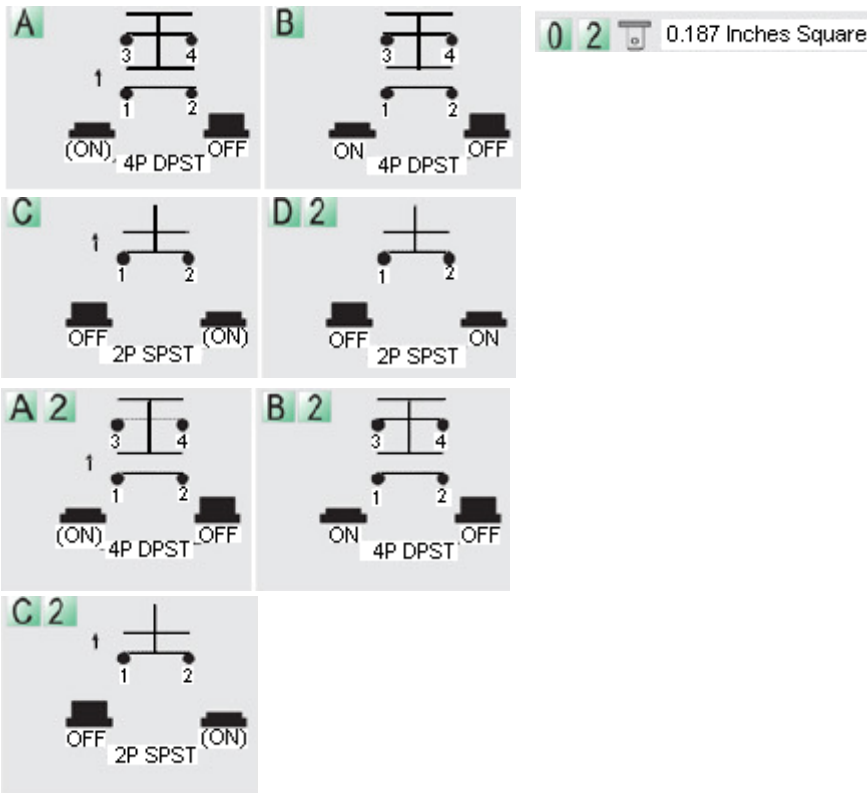
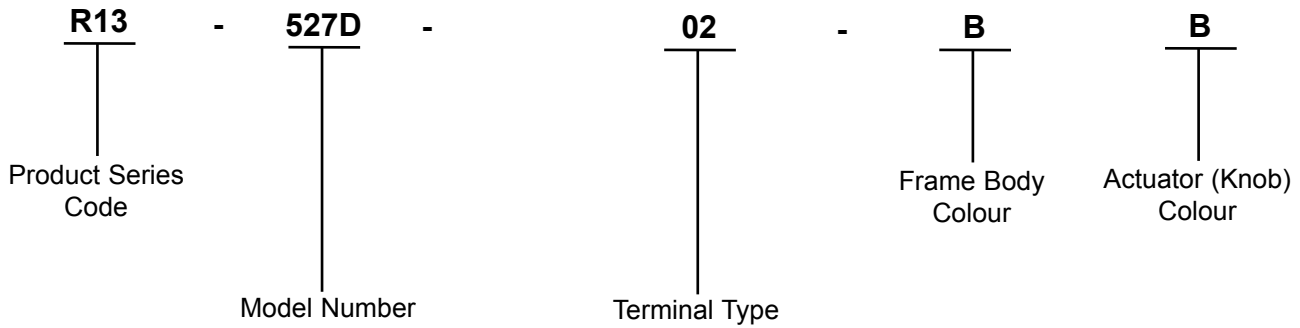

Frame Body Colour : B = Black.
 Actuator (Knob) Colour : B = Black.



Pushbutton Switches



Notes:

International Sales Offices:

	AUSTRALIA - Farnell Tel No: ++61 1300 361 005 Fax No: ++61 1300 361 225		FINLAND - Farnell Tel No: ++ 358 9 560 7780 Fax No: ++ 358 9 345 5411		ITALY - Farnell Tel No: ++ 39 02 93 995 200 Fax No: ++ 39 02 93 995 300		SPAIN - Farnell Tel No: 901 20 20 80 Fax No: 901 20 20 90
	AUSTRIA - Farnell Tel No: ++ 43 662 2180 680 Fax No: ++ 43 662 2180 670		FRANCE - Farnell Tel No: ++ 33 474 68 99 99 Fax No: ++ 33 474 68 99 90		MALAYSIA - Farnell-Newark Tel No: ++ 60 3 7873 8000 Fax No: ++ 60 3 7873 7000		SWEDEN - Farnell Tel No: ++ 46 8 730 50 00 Fax No: ++ 46 8 83 52 62
	BELGIUM - Farnell Tel No: ++ 32 3 475 2810 Fax No: ++ 32 3 227 3648		GERMANY - Farnell Tel No: ++ 49 89 61 39 39 39 Fax No: ++ 49 89 613 59 01		NETHERLANDS - Farnell Tel No: ++ 31 30 241 7373 Fax No: ++ 31 30 241 7333		SWITZERLAND - Farnell Tel No: ++ 44 204 64 64 Fax No: ++ 44 204 64 54
	BRAZIL - Farnell-Newark Tel No: ++ 55 11 4066 9400 Fax No: ++ 55 11 4066 9410		HONG KONG - Farnell-Newark Tel No: ++ 852 2268 9888 Fax No: ++ 852 2268 9899		NEW ZEALAND - Farnell Tel No: 0800 90 80 80 Fax No: 0800 90 80 81		UK - Farnell Tel No: ++ 44 8701 200 200 Fax No: ++ 44 8701 200 201
	CHINA - Farnell-Newark Tel No: ++86 10 6238 5152 Fax No: ++86 10 6238 5022		HUNGARY - Farnell Tel No: ++ 44 870 1200 208 Fax No: ++ 44 870 1200 209		NORWAY - Farnell Tel No: 800 146 70 Fax No: 800 146 76		UK - CPC ++ 44 8701 202 530 ++ 44 8701 202 531
	CZECH REPUBLIC - Farnell Tel No: ++ 44 870 1200 208 Fax No: ++ 44 870 1200 209		INDIA - Farnell Tel No: ++ 44 870 1200 208 Fax No: ++ 44 870 1200 209		PORTUGAL - Farnell Tel No: ++ 34 93 475 8804 Fax No: ++ 34 93 474 5288		USA - Newark Tel No: 800 463 9275
	DENMARK - Farnell Tel No: ++ 45 44 53 66 44 Fax No: ++ 45 44 53 66 06		IRELAND - Farnell Tel No: ++ 353 1 830 9277 Fax No: ++ 353 1 830 9016		RUSSIA - Farnell Tel No: ++ 44 870 1200 208 Fax No: ++ 44 870 1200 209	 EXPORT - Farnell Tel No: ++ 44 8701 200 208 Fax No: ++ 44 8701 200 209 For enquiries from all other markets	
	ESTONIA - Farnell Tel No: ++ 358 9 560 7780 Fax No: ++ 358 9 345 5411		ISRAEL - Farnell Tel No: ++ 180 937 0015 Fax No: ++ 180 937 0014		SINGAPORE - Farnell-Newark Tel No: ++ 65 6788 0200 Fax No: ++ 65 6788 0300		

<http://www.farnell.com>
<http://www.newark.com>
<http://www.cpc.co.uk>

Disclaimer This data sheet and its contents (the "Information") belong to the Premier Farnell Group (the "Group") or are licensed to it. No licence is granted for the use of it other than for information purposes in connection with the products to which it relates. No licence of any intellectual property rights is granted. The Information is subject to change without notice and replaces all data sheets previously supplied. The Information supplied is believed to be accurate but the Group assumes no responsibility for its accuracy or completeness, any error in or omission from it or for any use made of it. Users of this data sheet should check for themselves the Information and the suitability of the products for their purpose and not make any assumptions based on information included or omitted. Liability for loss or damage resulting from any reliance on the Information or use of it (including liability resulting from negligence or where the Group was aware of the possibility of such loss or damage arising) is excluded. This will not operate to limit or restrict the Group's liability for death or personal injury resulting from its negligence. SPC Multicomp is the registered trademark of the Group. © Premier Farnell plc 2007.

