

1591M

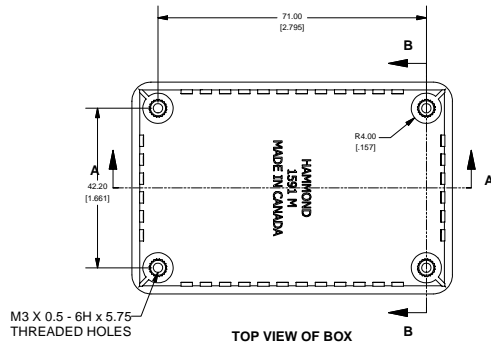

SIDE VIEW OF BOX



TOP VIEW OF BOX

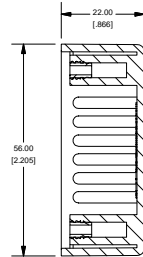

SECTION B-B
SCALE 1 : 1

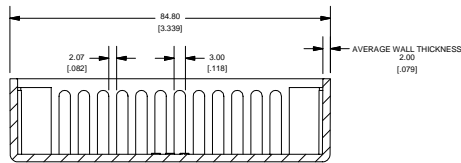

SECTION A-A
SCALE 1 : 1

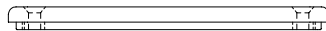

SIDE OF LID

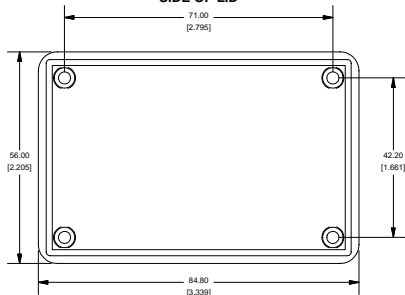

BOTTOM OF LID

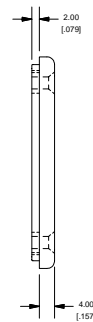

SIDE OF LID

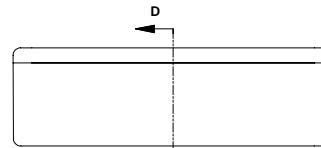

SIDE VIEW OF ASSEMBLY

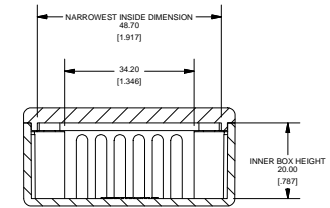

SECTION D-D
SCALE 1 : 1

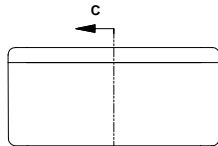
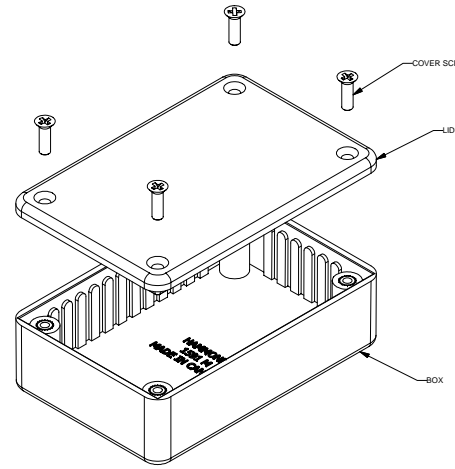

END VIEW OF ASSEMBLY

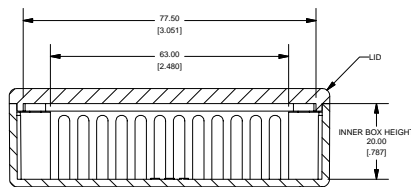

SECTION C-C
SCALE 1 : 1

PART NUMBERS		
1591M Enclosures		
Material	Colour	Part Number
ABS	Beige	1591MBG
	Black	1591MBK
	Blue	1591MBU
	Grey	1591MGY
	Black Shielded	1591RMBK
GP ABS	Black	1591MSBK
Translucent Polycarbonate	Ice Blue	1591MTBU
	IR Red	1591MTRD
	Crystal Clear	1591MTCL

Accessories		
	Description	Part Number
Used with ABS and Translucent Polycarbonate Enclosures	PC Board Card Adapters	See Accessories Section
	Flange Kits	See Accessories Section
	Replacement Screws, nickel plated M3 - 0.5 x 10mm, Pack of 100,	1591MS100
	Belt/Pocket Clip, w/ nylon screws (insulated to avoid interference) and mounting template	1591MS100BK (Black) 1599CLIPGY - Grey
	Clear Lids - clear, flame retardant polycarbonate - Lid ONLY	1591MC
Used with GP ABS Enclosure	PC Board Card Adapters	See Accessories Section
	Flange Kits	See Accessories Section
	Belt/Pocket Clip, w/ nylon screws (insulated to avoid interference) and mounting template	1599CLIP - Black 1599CLIPGY - Grey
	Replacement Screws, self tapping, black oxide, #4 x 0.5, Pack of 100	1591TS100BK
	Clear Lids - clear, flame retardant polycarbonate - Lid ONLY	1591MC

Required Torque on Fasteners (no lubrication)

M3 - 0.5 x 10mm Screws	30-40 cN*m
#4 x 0.5 Screws	30-40 cN*m

