

K 28 WP

8 Ω
50 Ω**2,8 cm (1") Breitbandlautsprecher**

mit Kunststoffmembran (Mylar). Gleichmäßiger Frequenzgang und gute Sprachverständlichkeit. Besonders geeignet für Anwendungen in sehr kleinen Geräten.

Funktionstüchtig bei Kälte gemäß EN 60068-2-1/EN 50155

2,8 cm (1") full-range speaker

with a plastic diaphragm (Mylar). Balanced frequency response and good voice reproduction. Particularly well suited to applications in very small devices.

Functionally at cold according to EN 60068-2-1/EN 50155

Anwendungsmöglichkeiten

- Kontroll-Lautsprecher für elektronische Geräte

Typical applications

- Monitoring speaker for electronic devices

Eigenschaften	Attributes
✓ Wetterfest	Weather-resistant
✓ UV-beständig	UV-resistant

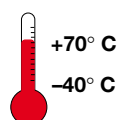
Schutzklasse / Protective system **IP65**

04/2007

Full-Range driver

K 28 WP

8 Ω
50 Ω

Technische Daten

Nennbelastbarkeit	1 Watt
Musikbelastbarkeit	2 Watt
Impedanz	8 Ω / 50 Ω
Übertragungsbereich (-10 dB)	300 – 20000 Hz
Mittlerer Schalldruckpegel	75 dB (1 W/1 m)
Resonanzfrequenz	500 Hz
Schwingspulendurchmesser	10 mm Ø
Schallwandöffnung	21 mm Ø
Gewicht	0,007 kg

Technical Data

Rated power	1 Watt
Maximum power	2 Watt
Impedance	8 Ω / 50 Ω
Frequency response (-10 dB)	300 – 20000 Hz
Mean sound pressure level	75 dB (1 W/1 m)
Resonant frequency	500 Hz
Voice coil diameter	10 mm Ø
Cutout diameter	21 mm Ø
Net weight	0,007 kg

04/2007

GERMANY
VISATON®

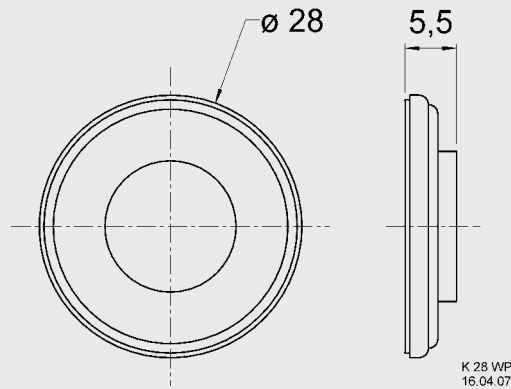

8 Ω

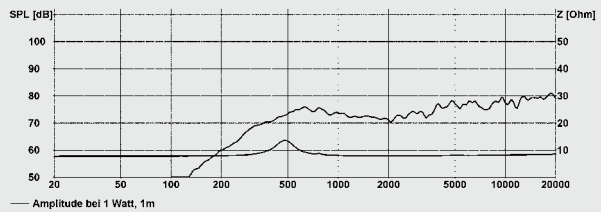

50 Ω

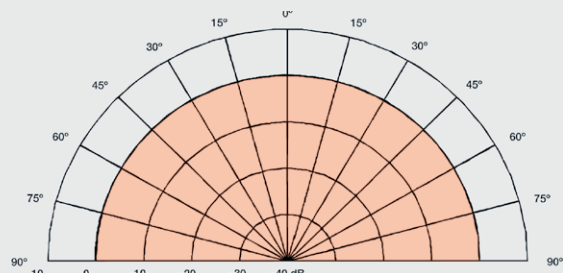
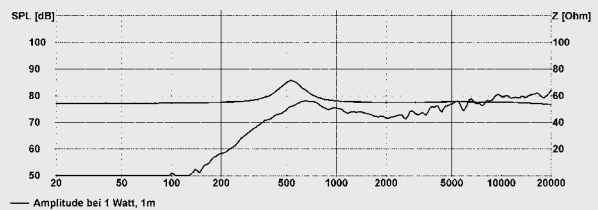

Abstrahlcharakteristik / Radiation pattern 1000 Hz

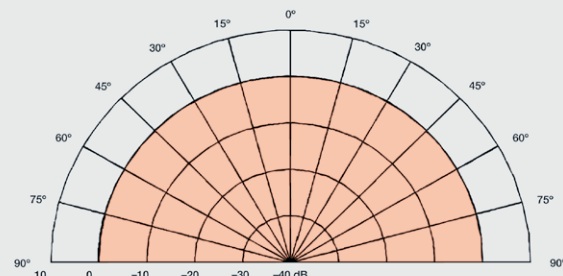

Abstrahlcharakteristik / Radiation pattern 5000 Hz

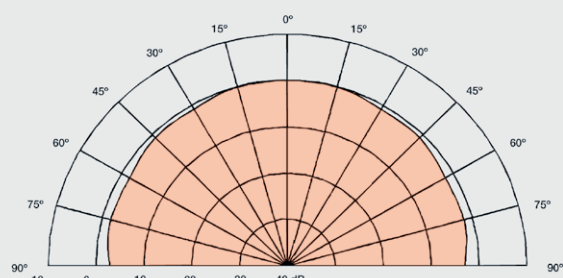

Abstrahlcharakteristik / Radiation pattern 8000 Hz