

N.S.F.

KEYLITE

A RANGE OF MODERN KEYBOARD
SWITCHES WITH ULTRA LIGHT TOUCH

REG PAT No 2064223A

REG DESIGNS

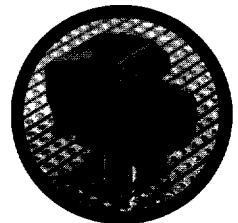
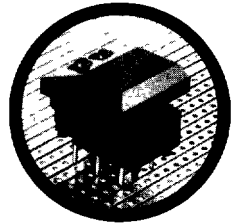
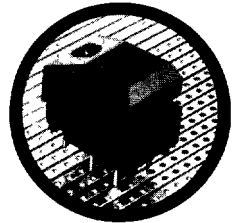
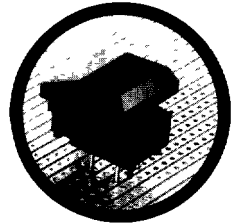
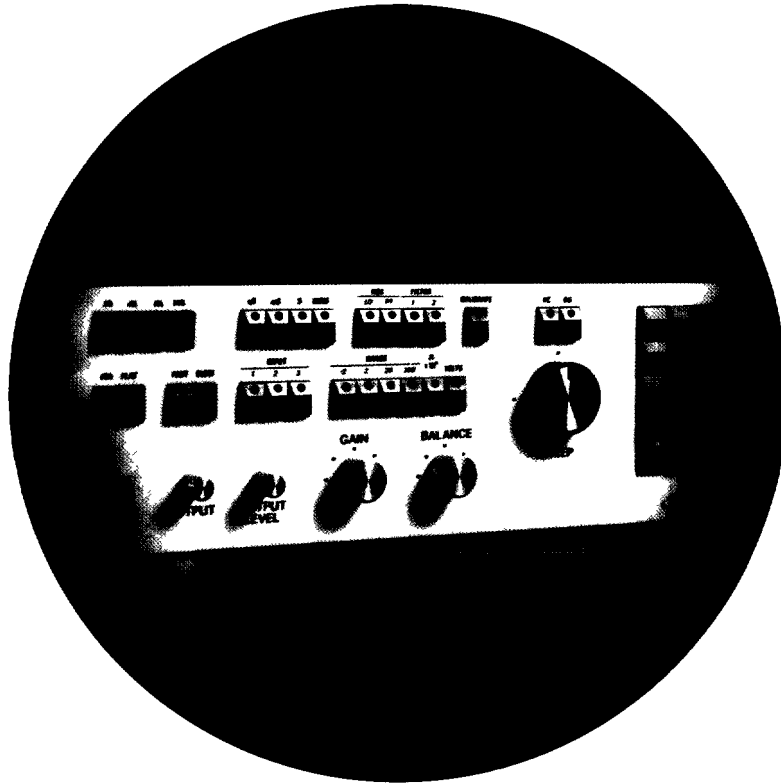

- FIVE MILLION OPERATIONS
- GOLD PLATED CONTACTS
- CONTACTS ON STANDARD MATRIX
- SNAP ACTION
- MODERN TREND STYLING
- INTERCHANGEABLE KEYS
- CHOICE OF KEY COLOUR
- UP TO TWO LEDS
- ANTI SOLDER-CREEPAGE LUGS
- HALF KEY MODELS

N.S.F. LIMITED

Switches and Controls

KEIGHLEY, WEST YORKSHIRE, BD21 5EF, ENGLAND

Telephone Keighley (0535) 61144 Telex 51270

Telegrams ENESEF Telex Keighley

DISTRIBUTED BY

--

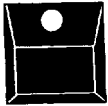

GENERAL SPECIFICATION

NOTE: Any requirements not covered by the information contained below should be referred to the N S F Technical Service Department who will be pleased to assist in solving your switching problems

Actuation	Single pole changeover, momentary.
Terminations.	Printed circuit pins
Ratings	Switch. standard 10mA 24Vdc Other ratings on request
Contact resistance	Initial 50 milliohms maximum
Insulation resistance	10 ⁹ ohms minimum
Contacts	Gold plating over silver plated brass
Key width	Narrow (12mm), Broad (17mm)
Key colours	Standard, black Other colours to order.
Operating force	2N maximum
Total key travel	2.5mm maximum
Contact travel	1mm minimum
Contact bounce	2ms maximum
Mechanical life	5 × 10 ⁶ operations at maximum load
Ambient temperature range	-25 to +85°C
Mounting method.	Direct soldering onto standard matrix printed circuit board, with levelling facilities
Materials	Housing, polycarbonate Key, ABS.
Marking	Available to order. Colours and type style to be specified

LED SPECIFICATIONS			
Colour	Red	Green	Yellow
Part No	623315	623315-2	623315-3
Maximum ratings			
Forward current	30mA	30mA	30mA
Forward voltage	3.0 @ 10mA	3.0 @ 20mA	3.0 @ 10mA
Intensity (typical)	2.0 mcd @ 10mA	1.5 mcd @ 20mA	2.0 mcd @ 10mA

For further details please contact N S F

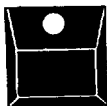

DIMENSIONS

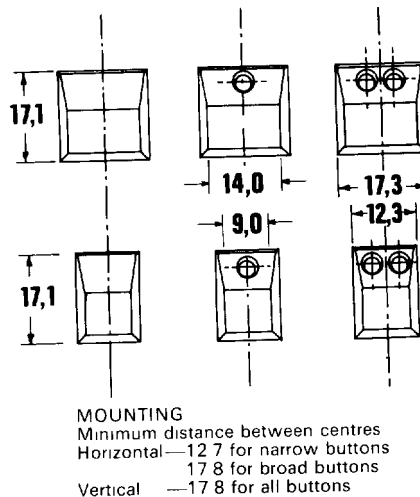
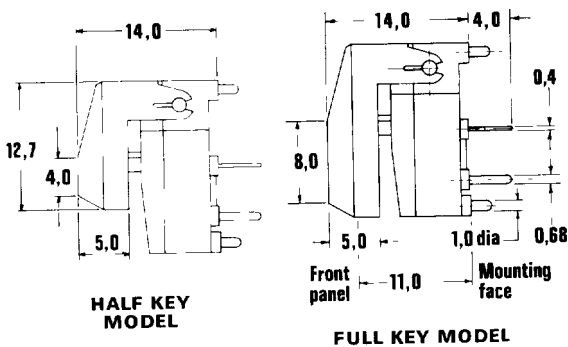

Termination and Circuitry Details (viewed from underneath)

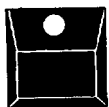
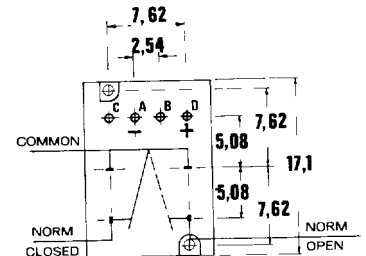

FEATURES

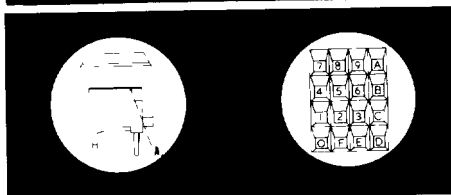

RECOMMENDED KEY REMOVAL METHOD
1 Operate switch 2 Insert small screwdriver into resulting gap at 'A' 3 Gently twist
NOTE When removing keys from within a matrix e.g. No. 3 above, first remove Nos. 9 and 6 by the above method, then remove No. 3

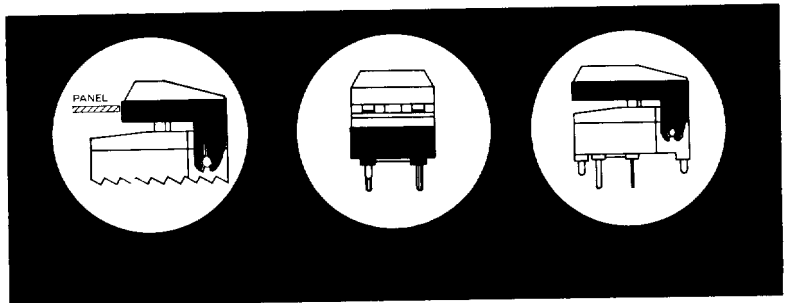

Half key variation enables legends to be standardised or alternative functions to be marked.

Stand-off lugs minimize solder-creepage

Keys are detachable and interchangeable with improved push-on design

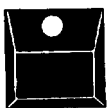

CATALOGUE DATA

Switch type	Key width (mm)	No of LEDs
K	12 (narrow) 17 (broad)	None L1 (one) L2 (two)*

* When specifying 2 LEDs, please order from left to right

Key colour Standard, black
To specification, grey, red, orange, blue, white, green, and yellow

LED colour Standard, red
To specification, green and yellow